



# Bobcat®

COMPACT EXCAVATORS

E26 E27z E27



*One Tough Animal®*

# REDEFINING INDUSTRY STANDARDS...



The Bobcat R-Series E26 – E27z – E27 are built around the operator to provide a roomy comfortable cab, easy operation, and great visibility. These machines are amazingly stable – providing both high-performance and safe transportability.

The lower transport weight means that they offer a blend of traditional Bobcat performance and best-in-class controllability. Plus, for guaranteed reliability and durability, the latest technology has been used throughout their design and manufacturing – so you can work without any interruptions.



- Enjoy the famous Bobcat performance with even smoother working functions
- 5 customizable hydraulic auxiliary circuits – excellent stability and ease as you operate even the most complex and heavy attachments
- Full control of your surroundings – thanks to the great visibility through larger glass area and excellent ergonomics
- All configurations fit on the trailer - and no worries about weight limits
- With the E27z Zero House Swing (ZHS) – benefit from 20% more freedom of movement than with a classical zero tail swing (ZTS)

### **E26 – Unique, lighter and tougher**

- Perfect transport weight w/ cab: below 2.5 tons
- Innovative Cylinder Inside Boom for extra robustness
- Exceptional value for money

### **E27z – More stability and comfort with ZHS format**

- Zero House Swing for peace of mind, even with open door and heavy counterweight
- Largest cab on the market for this size of machine
- Lower weight so more attachments can be towed together on a trailer without compromising performance
- Highest flexibility of movements when working close to walls

### **E27 – Better performance**

- Unique combination of superior stability, + class-leading digging force
- Transport weight below the weight limits for appropriate trailers
- Only 220 mm (std.)/ 280 mm (heavy) of tail overhang which allows the machine to be still operated in confined spaces
- Ideal tool for highly demanding applications where performance together with transportability have a priority over compactness

# LOWER TRANSPORT WEIGHT, GREATER 360° STABILITY

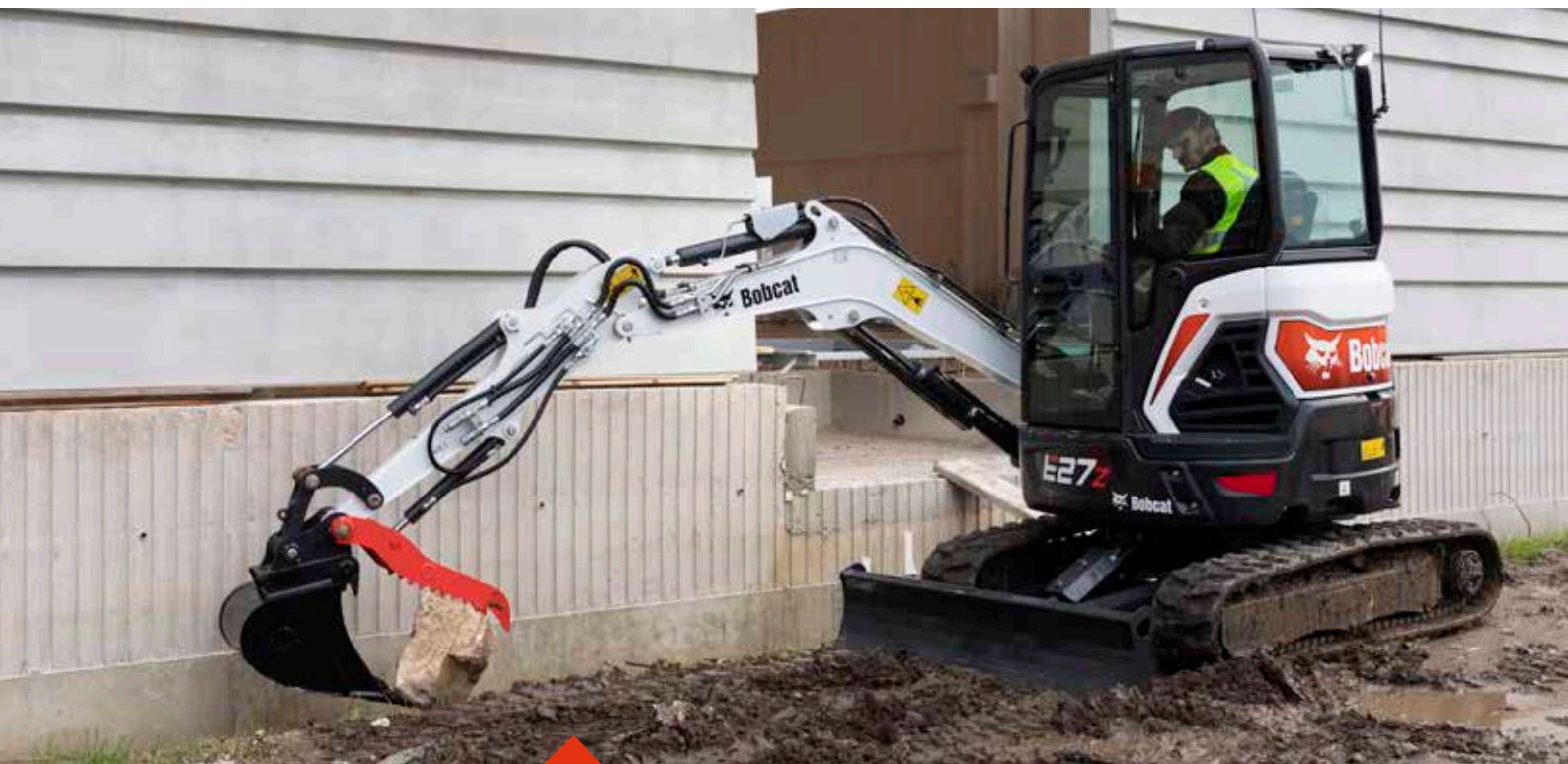

## The difficult match

The goal: greater stability while making the machines lighter for comfortable transport on trailers. We achieved this by optimized geometry and new counterweight concept. The improved stability makes our new models ready for the most difficult operations while maintaining the ZHS or RTS functionality.



## Transportability

- The European Transport Regulations specify a maximum towable weight of 3500 kg.
- All 3 new Bobcat models are towable on most trailers in multiple configurations.
- And transportability is made even easier with the new integrated upper-structure tie-down points.

# BEST-IN-CLASS CONTROLLABILITY WITH EXCEPTIONAL PERFORMANCE



## Zero House Swing (ZHS) concept for E27z

The Bobcat Zero House Swing (ZHS) concept enhances Zero Tail Swing (ZTS) functionality by further protecting the front upper structure corners as they turn within the swing circle.

The design of Bobcat machines also eliminates the 'unicorn' effect of having the boom swing cylinder exposed during parallel digging.



## Smooth operation

While making these machines smoother and easier to operate, we kept the famous Bobcat speed. The optimized hydraulic system and the new joysticks with dual curve response guarantee exceptional performance and best-in-class controllability.

# BUILT AROUND THE OPERATOR

Great features for extra comfort  
 Bobcat's new E26, E27z and E27 excavators offer +25.4 mm wider operator space and a new luxury cab that delivers best-in-class visibility. The new features also include exterior covers that open and close effortlessly for easy maintenance.

## 1. Instrument panel

Clear and easy to reach, the display features an indicator for the automatic light switch-off function, optional keyless ignition and operational information such as hours, rpm and job clock.

## 2. Second speed, auto-shift and auto-idle

The travel motors automatically return to high speed after downshifting under load. So, turns are smoother and dozing work is easier. Auto-idle is available as an option to reduce fuel consumption.



1 - Standard display



1 - Deluxe display

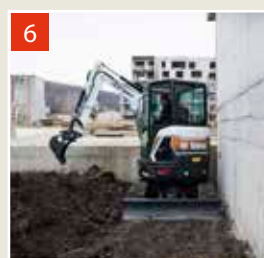
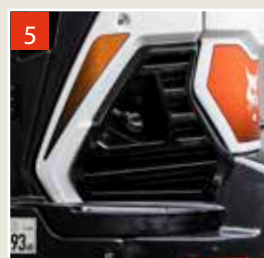
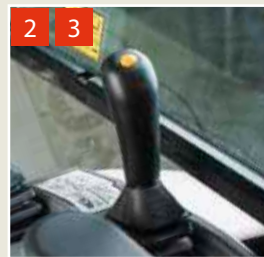

### 3. Floating blade

Automatically controlled blade flotation for quick and easy levelling operations.

### 4. Thumb control for boom swing and auxiliary hydraulics

A thumb control is integrated in the joystick for better metering of the boom swing and the proportional auxiliary hydraulics.

### 5. External fuel cap

The external lockable fuel cap makes refueling easy and safe. For extra convenience when refilling, a warning beep sounds when the maximum fuel level has been reached.

### 6. Zero Tail Swing design

The upper structure remains within the width of the tracks even when operated with the door open.



# DURABILITY & RELIABILITY

## Reliability added in every feature

- Rear tailgates protected by casted counterweights
- Metal covers can be opened or bolted on
- Reinforced workgroup to minimize freeplay and maximize durability
- New robust protection for boom cylinder
- Proven boom and dipperstick design
- Blade design enhances robustness and self-cleaning
- Increased protection for hoses, pipes and valves
- Wrenchless hydraulic hose technology helps prevent leakage
- 2-piece blade cylinder hoses
- Maintenance-free track rollers and idler
- Auto-tensioning and maintenance-free fan and alternator
- Battery disconnect for storage and transport



## Tough materials, tested design

Highly durable materials make the Bobcat excavators hard-wearing and robust. The design features are tested under extreme conditions – and the heavy steel gauge tailgate ensures extra durability and peace of mind while working.



**Enhanced level of Fit & Finish for exterior covers, cab & canopy, workgroup**  
**Paint quality meets highest customer expectations**



# MAINTENANCE AND SERVICE



**Famous Bobcat access for regular maintenance**

**Side-by-side coolers for easy cleaning**

**Easy access to upper structure components thanks to:**

- 2-piece floor mat
- Easy-to- remove floor covers

**Diagnostics are easy thanks to display error codes on control panel and service tool connection:**

- Connector for easy installation of GPS unit (telemetry)

**Designed and tested for life-long performance:**

- Materials, components and structures have been tested stringently for endurance under extreme conditions

**The unrivaled design, quality and durability of Bobcat Genuine Parts ensure minimum downtime and keep your machines performing optimally.**

Your compact equipment is essential to your business. As it completes difficult tasks on time and keeps your schedule moving forward, it generates maximum income. So, a solid maintenance plan can help you rest easy.

**BobCARE PM is Bobcat's factory-advised and scheduled inspection, service and maintenance program**

- Reduces financial risks and safeguards your assets thanks to proper maintenance
- Increases your productivity

**Extended warranty at Protection Plus conditions**

- Extends your sense of security by minimizing repair costs
- Assures full confidence in repair quality thanks to certified mechanics and Bobcat Genuine Spare Parts and materials



**Quick and easy servicing**

Bobcat is expert at designing, engineering and manufacturing the tough compact equipment you rely on. With BobCARE PM planned maintenance and Protection Plus Extended Warranty, you can benefit from our expertise for the full lifetime of your machines.

# E26 E27z E27 — SPECIFICATIONS

	E26	E27z	E27
<b>WEIGHTS</b>			
Operating weight with cab and bucket (ISO 6016)	2608 kg	2705 kg	2683 kg
Weight reduction with canopy	-118 kg	-118 kg	-118 kg
Additional weight for steel tracks	–	119 kg	119 kg
Additional weight for long dipperstick	–	10 kg	–
Additional weight for heavy counterweight	–	123 kg	147 kg
<b>ENGINE</b>			
Make / model	Kubota / D1105-E4B-BCZ-1	Kubota / D1105-E4B-BCZ-1	Kubota / D1305-E4B-BCZ-1
Fuel	Diesel	Diesel	Diesel
Cooling	Liquid, forced circulation	Liquid, forced circulation	Liquid, forced circulation
Number of cylinders	3	3	3
Displacement	1123 cm <sup>3</sup>	1123 cm <sup>3</sup>	1261 cm <sup>3</sup>
Maximum power @ 2400 rpm (ISO 14396)	15.4 kW	15.4 kW	18.2 kW
Maximum torque (SAE)	71.2 Nm	71.2 Nm	81.3 Nm
<b>PERFORMANCE</b>			
Digging force, dipperstick (ISO 6015)	15690 N	16200 N	16030 N
Digging force, long dipperstick (ISO 6015)	–	13470 N	–
Digging force, bucket (ISO 6015)	23720 N	23720 N	26520 N
Drawbar pull	29080 N	29023 N	28949N
Travel speed, low range	2.5 km/h	2.5 km/h	3.0 km/h
Travel speed, high range	4.3 km/h	4.3 km/h	5.1 km/h
<b>HYDRAULIC SYSTEM</b>			
Pump type	Dual outlet variable displacement piston pump with gear pumps		
Total hydraulic capacity	87 L/min	87 L/min	94.3 L/min
Auxiliary flow	50 L/min	50 L/min	53.75 L/min
Auxiliary relief	180 bar	180 bar	180 bar
<b>SLEW SYSTEM</b>			
Boom swing, left	60°	70°	70°
Boom swing, right	60°	55°	55°
Slew rate	9.3 RPM	9.3 RPM	9.3 RPM
<b>FLUID CAPACITIES</b>			
Cooling system	4.3 L	4.3 L	4.5 L
Engine lubrication plus oil filter	3.6 L	3.6 L	4 L
Fuel reservoir	34.4 L	34.4 L	34.4 L
Hydraulic reservoir	10.2 L	10.2 L	10.2 L
Hydraulic system	23 L	23 L	24 L
Final drive case (each)	0.6 L	0.6 L	0.6 L
<b>ENVIRONMENTAL</b>			
Noise level LpA/EU Directive 2006/42/EC	80 dB(A)	77 dB(A)	78 dB(A)
Noise level LWA/EU Directive 2000/14/EC	93 dB(A)	93 dB(A)	94 dB(A)
Whole body vibration (ISO 2631–1)	0.11 ms <sup>-2</sup>	0.18 ms <sup>-2</sup>	0.13 ms <sup>-2</sup>
Hand-arm vibration (ISO 5349–1)	0.5 ms <sup>-2</sup>	0.51 ms <sup>-2</sup>	0.44 ms <sup>-2</sup>

## STANDARD FEATURES

### E26 - E27z - E27

Adjustable double acting auxiliary hydraulic (AUX1) with Quick Couplers  
 Battery disconnect  
 Blade float feature  
 Control console locks  
 Cup holder  
 Engine/hydraulic monitor with shutdown  
 Foldable and ergonomic pedals  
 Full fuel warning alarm  
 Grease gun holder  
 Horn  
 Proportional fingertip auxiliary and boom swing offset hydraulic control  
 Retractable seat belt  
 TOPS/ROPS/FOPS canopy \*

Two-speed travel with Auto shift  
 Upper structure four-point tie down  
 Water separator  
 Work light (boom)  
 Warranty: 12 months, 2000 hours (whichever occurs first)

### E26

1500 mm dozer blade  
 250 mm rubber track  
 Seat with high back

### E27 - E27z

1500 mm dozer blade  
 300 mm rubber tracks  
 Clamp ready  
 Suspension seat

## OPTIONS

### E26 - E27z - E27

1st AUX hydraulic on arm  
 2nd AUX hydraulics  
 Additional lights (2+1)  
 AM/FM stereo radio  
 Beacon  
 Bucket diverter valves (AUX3) kit  
 Case drain line  
 Dlx textile suspension seat  
 Direct-to-tank-AUX1 line  
 Fire extinguisher  
 Keyless ignition  
 Klac coupler  
 Left and right mirror  
 MS03 coupler  
 Object handling device (safety valves + overload warning device + lift eye)  
 TOPS/ROPS/FOPS cab with heater  
 Travel motion alarm

### E26

Suspension seat

### E27 - E27z

Auto idle  
 Bobcat hydr. pin grabber  
 Clamp with AUX1 diverter  
 Heavy counterweight  
 HS03 coupler or tilt coupler with lift eye  
 Hydr. coupler lines (AUX5)  
 LED lights set  
 Steel tracks  
 Tilt coupler lines (AUX4)

### E27

Long dozer blade

\*Roll Over Protective Structure (ROPS) – Meets requirements of ISO 3471. Tip Over Protective Structure (TOPS) – Meets requirements of ISO 12117. Falling Object Protective Structure (FOPS) – Meets requirements of ISO 3449.

## WORKING RANGE

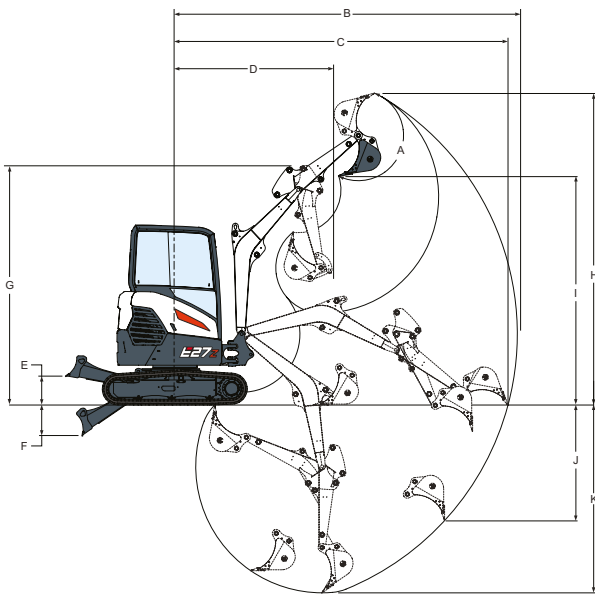

## DIMENSIONS

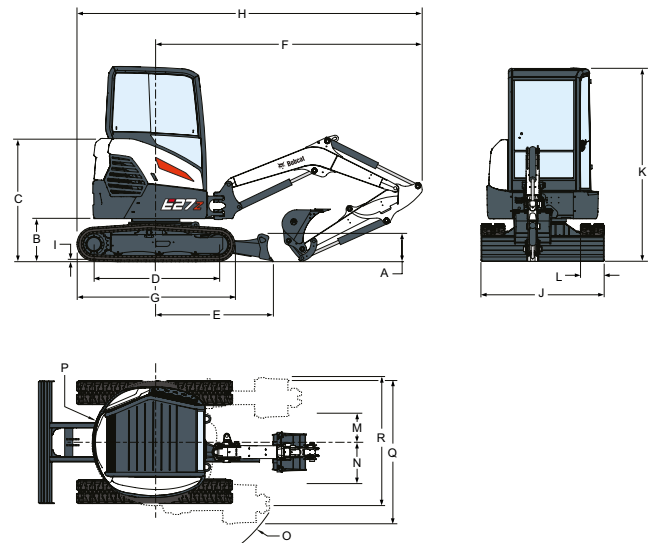

	A	B	B*	C	C*	D	D*	E	E**	F	F**
<b>E26</b>	185°	4542	—	4413	—	2052	—	385	—	420	—
<b>E27z</b>	185°	4644	4931	4518	4814	2131	2135	385	—	420	—
<b>E27</b>	185°	4721	—	4604	—	1924	—	346	385	302	420

	G	G*	H	H*	I	I*	J	J*	K	K*
<b>E26</b>	3104	—	4006	—	2845	—	1474	—	2568	—
<b>E27z</b>	3247	3239	4230	4430	3043	3243	1567	1818	2547	2847
<b>E27</b>	3240	—	4429	—	3243	—	1825	—	2847	—

	A	B	C	D	E	E**	F	G	H	H***	I	J
<b>E26</b>	319	539	1540	1543	1462	—	3192	1965	4174	—	21	1500
<b>E27z</b>	319	539	1540	1543	1462	—	3343	1965	4325	—	21	1550
<b>E27</b>	319	539	1540	1543	1245	1465	3135	1965	4079	4190	21	1550

	K	L	M	N	O	P	P***	Q	Q***	R	R***
<b>E26</b>	2438	250	580	705	1755	820	—	1741	—	1616	—
<b>E27z</b>	2438	300	565	773	1726	785	—	1808	—	1599	—
<b>E27</b>	2438	300	393	576	1575	995	1055	1808	1868	1731	1791

\* with long dipperstick, \*\* with long blade, \*\*\* with heavy counterweight



# E26 E27z E27 — LIFTING CAPACITIES

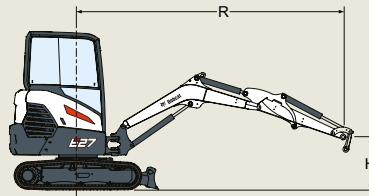

Over blade, blade down			Over blade, blade up				Over side, blade up								
<b>E26 - RATED LIFT CAPACITY WITH CANOPY</b>															
Lift Point Height [H]	Max. radius [R] (mm)	Lift at max. radius (kg)	Lift radius [R] (kg)			Max. radius [R] (mm)	Lift at max. radius (kg)	Lift radius [R] (kg)			Max. radius [R] (mm)	Lift at max. radius (kg)	Lift radius [R] (kg)		
			2000 mm	3000 mm	4000 mm			2000 mm	3000 mm	4000 mm			2000 mm	3000 mm	4000 mm
3000 mm	3040	527*	-	-	-	3040	433	-	-	-	3040	378	-	-	-
2000 mm	3700	568*	-	535*	-	3700	334	-	535*	-	3700	289	-	399	-
1000 mm	3900	627*	-	751*	-	3900	308	-	456	-	3900	260	-	377	-
Ground	3740	703*	1695*	916*	-	3740	327	816	445	-	3740	270	632	364	-
-1000 mm	3160	804*	1602*	886*	-	3160	427	876	454	-	3160	345	707	373	-

Over blade, blade down			Over blade, blade up				Over side, blade up								
<b>E26 - RATED LIFT CAPACITY WITH CAB</b>															
Lift Point Height [H]	Max. radius [R] (mm)	Lift at max. radius (kg)	Lift radius [R] (kg)			Max. radius [R] (mm)	Lift at max. radius (kg)	Lift radius [R] (kg)			Max. radius [R] (mm)	Lift at max. radius (kg)	Lift radius [R] (kg)		
			2000 mm	3000 mm	4000 mm			2000 mm	3000 mm	4000 mm			2000 mm	3000 mm	4000 mm
3000 mm	3040	527*	-	-	-	3040	527*	-	-	-	3040	396	-	-	-
2000 mm	3700	568*	-	535*	-	3700	353	-	535*	-	3700	304	-	417	-
1000 mm	3900	627*	-	751*	-	3900	326	-	481	-	3900	273	-	395	-
Ground	3740	703*	1695*	916*	-	3740	346	861	470	-	3740	284	664	382	-
-1000 mm	3160	804*	1602*	886*	-	3160	451	921	479	-	3160	362	739	392	-

Over blade, blade down			Over blade, blade up				Over side, blade up								
<b>E27z - RATED LIFT CAPACITY WITH CANOPY, STANDARD ARM AND STANDARD COUNTERWEIGHT</b>															
Lift Point Height [H]	Max. radius [R] (mm)	Lift at max. radius (kg)	Lift radius [R] (kg)			Max. radius [R] (mm)	Lift at max. radius (kg)	Lift radius [R] (kg)			Max. radius [R] (mm)	Lift at max. radius (kg)	Lift radius [R] (kg)		
			2000 mm	3000 mm	4000 mm			2000 mm	3000 mm	4000 mm			2000 mm	3000 mm	4000 mm
3000 mm	3210	585*	-	585*	-	3210	445	-	538*	-	3210	388	-	425	-
2000 mm	3810	601*	-	605*	-	3810	349	-	510	-	3810	296	-	436	-
1000 mm	4030	636*	-	833*	642*	4030	317	-	484	320	4030	271	-	408	274
Ground	3880	684*	1722*	957*	-	3880	337	869	491	-	3880	285	693	393	-
-1000 mm	3330	746*	1551*	916*	-	3330	436	1002	514	-	3330	362	752	423	-

Over blade, blade down5			Over blade, blade up				Over side, blade up								
<b>E27z - RATED LIFT CAPACITY WITH CAB, LONG ARM AND HEAVY COUNTERWEIGHT</b>															
Lift Point Height [H]	Max. radius [R] (mm)	Lift at max. radius (kg)	Lift radius [R] (kg)			Max. radius [R] (mm)	Lift at max. radius (kg)	Lift radius [R] (kg)			Max. radius [R] (mm)	Lift at max. radius (kg)	Lift radius [R] (kg)		
			2000 mm	3000 mm	4000 mm			2000 mm	3000 mm	4000 mm			2000 mm	3000 mm	4000 mm
3000 mm	3630	497*	-	-	-	3630	497*	-	-	-	3630	378	-	-	-
2000 mm	4070	526*	-	492*	510*	4070	361	-	492*	373	4070	307	-	492*	322
1000 mm	4270	565*	-	722*	576*	4270	336	-	566	372	4270	282	-	474	310
Ground	4150	614*	1614*	918*	648*	4150	350	982	549	370	4150	292	780	453	308
-1000 mm	3600	665*	1559*	937*	-	3600	428	1102	568	-	3600	352	833	451	-
-2000 mm	2550	697*	1070*	-	-	2550	697*	1070*	-	-	2550	697*	1070*	-	-

Over blade, blade down			Over blade, blade up				Over side, blade up								
<b>E27 - RATED LIFT CAPACITY WITH CANOPY, STANDARD COUNTERWEIGHT</b>															
Lift Point Height [H]	Max. radius [R] (mm)	Lift at max. radius (kg)	Lift radius [R] (kg)			Max. radius [R] (mm)	Lift at max. radius (kg)	Lift radius [R] (kg)			Max. radius [R] (mm)	Lift at max. radius (kg)	Lift radius [R] (kg)		
			2000 mm	3000 mm	4000 mm			2000 mm	3000 mm	4000 mm			2000 mm	3000 mm	4000 mm
3000 mm	3400	605*	-	-	-	3400	441	-	-	-	3400	402	-	-	-
2000 mm	3900	640*	-	609*	-	3900	372	-	609*	-	3900	328	-	492	-
1000 mm	4070	690*	1380*	840*	694*	4070	347	962	546	360	4070	303	826	470	311
Ground	3920	743*	1834*	1047*	-	3920	366	987	547	-	3920	316	810	463	-
-1000 mm	3440	823*	1717*	1037*	-	3440	460	1099	569	-	3440	387	845	466	-
-2000 mm	2430	875*	1135*	-	-	2430	875*	1135*	-	-	2430	741	1135*	-	-

Over blade, blade down			Over blade, blade up				Over side, blade up								
<b>E27 - RATED LIFT CAPACITY WITH CAB, HEAVY COUNTERWEIGHT</b>															
Lift Point Height [H]	Max. radius [R] (mm)	Lift at max. radius (kg)	Lift radius [R] (kg)			Max. radius [R] (mm)	Lift at max. radius (kg)	Lift radius [R] (kg)			Max. radius [R] (mm)	Lift at max. radius (kg)	Lift radius [R] (kg)		
			2000 mm	3000 mm	4000 mm			2000 mm	3000 mm	4000 mm			2000 mm	3000 mm	4000 mm
3000 mm	3400	605*	-	-	-	3400	605*	-	-	-	3400	485	-	-	-
2000 mm	3900	640*	-	609*	-	3900	455	-	609*	-	3900	398	-	609*	-
1000 mm	4070	690*	1380*	840*	694*	4070	426	1173	662	441	4070	370	994	567	380
Ground	3920	743*	1834*	1047*	-	3920	449	1199	663	-	3920	387	978	560	-
-1000 mm	3440	823*	1717*	1037*	-	3440	557	1310	686	-	3440	469	1013	563	-
-2000 mm	2430	875*	1135*	-	-	2430	875*	1135*	-	-	2430	875*	1135*	-	-

\* Rated hydraulic lift capacity. The lifting capacities are based on ISO 10567 and do not exceed 75 % of the static tilt load of the machine or 87 % of the hydraulic lifting capacity of the machine.



**Bobcat is a Doosan Company.**  
Doosan is a global leader in construction equipment, power & water solutions, engines, and engineering proudly serving customers and communities for more than a century. | Bobcat and the Bobcat logo are registered trademarks of Bobcat Company in the United States and various other countries.  
©2018 Bobcat Company. All Rights Reserved.



# Bobcat®

www.bobcat.com

Certain specification(s) are based on engineering calculations and are not actual measurements. Specification(s) are provided for comparison purposes only and are subject to change without notice. Specification(s) for your individual Bobcat equipment may vary based on normal variations in design, manufacturing conditions, and other factors. Pictures of Bobcat units may show other than standard equipment.

